

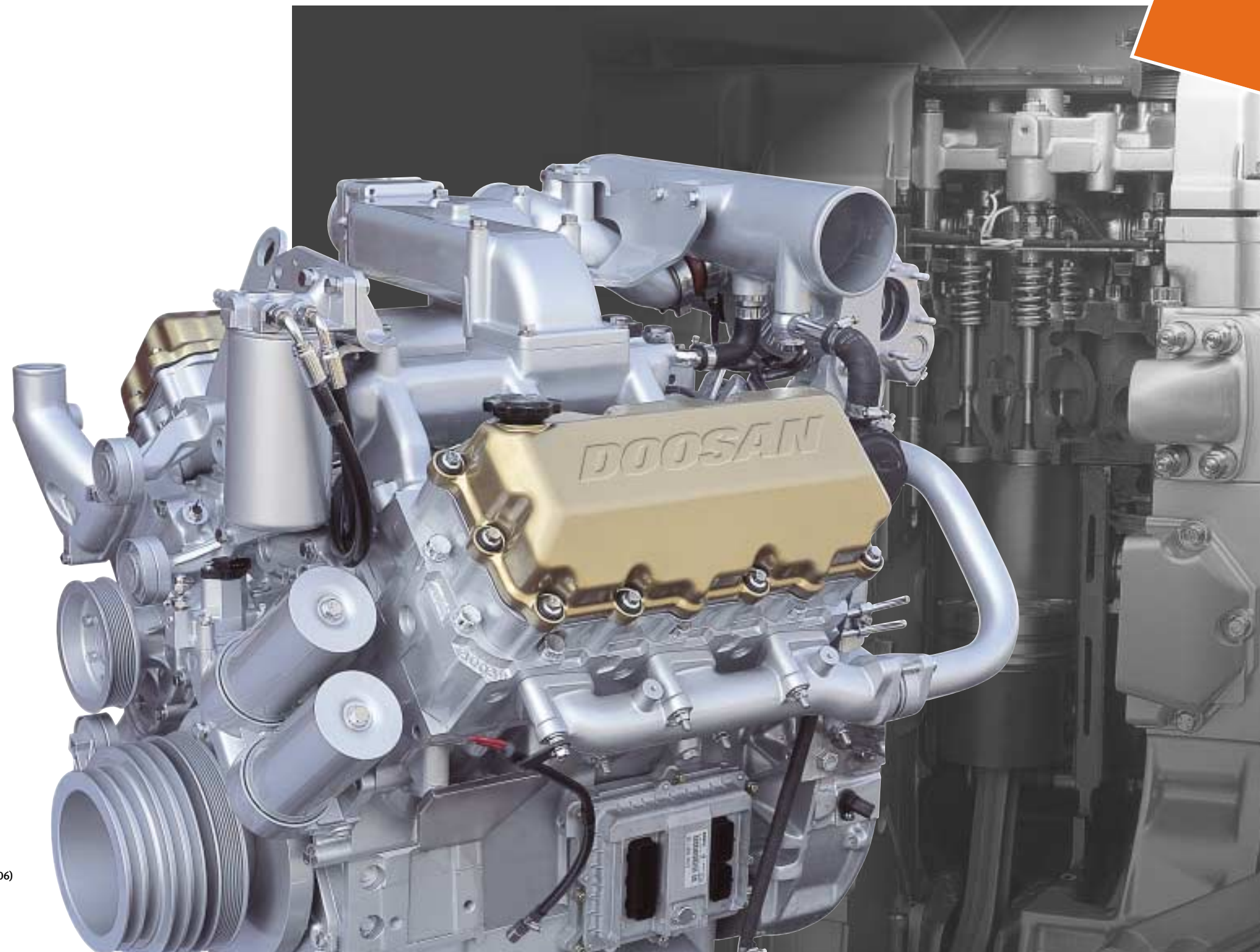

Doosan Infracore
Engines & Materials

Clean Power Solution Diesel & Gas Engine



Doosan Infracore
Engines & Materials

Seoul Office : Overseas Marketing & Sales
Engines & Materials BG
Doosan Infracore Co., Ltd.
23rd Floor, Doosan Tower, 18-12, Euljiro 6-ga,
Jung-gu, Seoul, Korea.
Tel : +82-2-3398-8530~8546
Fax : +82-2-3398-8509

Web site : <http://engine.doosaninfracore.co.kr>

(Dec.2006)

Doosan Infracore

The Introduction of Engines and Materials BG

We started producing diesel engines for the first time in 1958. Our production facility is located in Incheon, Korea and entered full production under the license of MAN technology in 1975 and ISUZU technology in 1979. Furthermore, we began to produce the CNG engine in 1998 so that our reinforced line up from Diesel engine to Natural Gas engine could supply more various choices and meet the various needs for customers.

We have three sites in Korea : an engine production facility, two foundry shops producing cast components in Incheon, and an engine R&D facility in Kunsan. Now 600 employees are employed in Engine Facility .

We have steadily expanded our business on the foundation of accumulated technology & know-how, continued investment in R&D, and our abundant

experience of developing over 1,200 different applications for the various equipments. We now produce 66 typical models under the 1,200 horsepower.

Currently, with streamlined and integrated production facilities including iron casting, machining, and assembly line, the Incheon engine shop has the annual capacity of 20,000 units for small engine, 24,000 units for medium, 12,000 units for large, and 8,000 units for marine application engines. The Incheon foundry shop has the annual capacity of 36,000 tons and the Jinheung foundry shop for 24,000 tons.

The business organization in terms of its goods is largely divided into four groups - commercial vehicle engine, industrial engine, marine engine, and genset.



Engines & Materials BG



History

- 1958 Produce the Marine Engines co-developed with AVL
- 1975 Begin to produce of medium duty engines under license of MAN(Germany)
- 1979 Begin to produce of light duty engines under license of ISUZU(Japan)
- 1985 Produce our own designed engine, STORM series
- 1994 Acquire the ISO9001 certification
- 1995 Produce our own designed engine, DE & DV series (EURO- I)
- 1997 Acquire ISO14001 certification
- 1998 Produce EURO-II engines(TIS) and CNG engines
- 2004 Produce DL08, DV11(EURO-III, TIER-III)
- 2006 Start to produce DL06(EURO-III, TIER-III)

Quality Award

- 1983 Grand Prix of Quality Control (Honor of President/ Korea)
- 1986 Iron Medal of Industry with STORM engine (Honor of President/ Korea)
- 1994 Acquire ISO 9001/9002
- 1995 Gold Medal of Q.C.C. Contest(Honor of President/ Korea)
- 1996 Grand Prix Tech. of Environmental Reservation with DE12TI engine (Honor of President/ Korea)
- 1997 Grand Prix of Quality Management (Honor of President/ Korea)
- Acquire ISO 14001
- 1999 Korean 100 Technology of 20th century with GE12TI CNG Engine (Seoul Economy Daily, Ministry of Science and Technology/Korea)
- 2000 Best Award on Engine with GE12TI engine (NGV2000)
- 2006 Award on GM Group Supplier of the Year (SOY)

Products

- Vehicle and Industrial Engine Group** Diesel & CNG Engine for Truck, Bus and Agricultural/ Construction Machinery, etc
- Marine Engine Group** Diesel Engine for marine propulsion and Generator
- Generator Engine Group** Diesel & NG Engine for Generator
- Materials Group** Cast Iron Products
Aluminum Cast Products
Sintered Metal Products

Technological Development

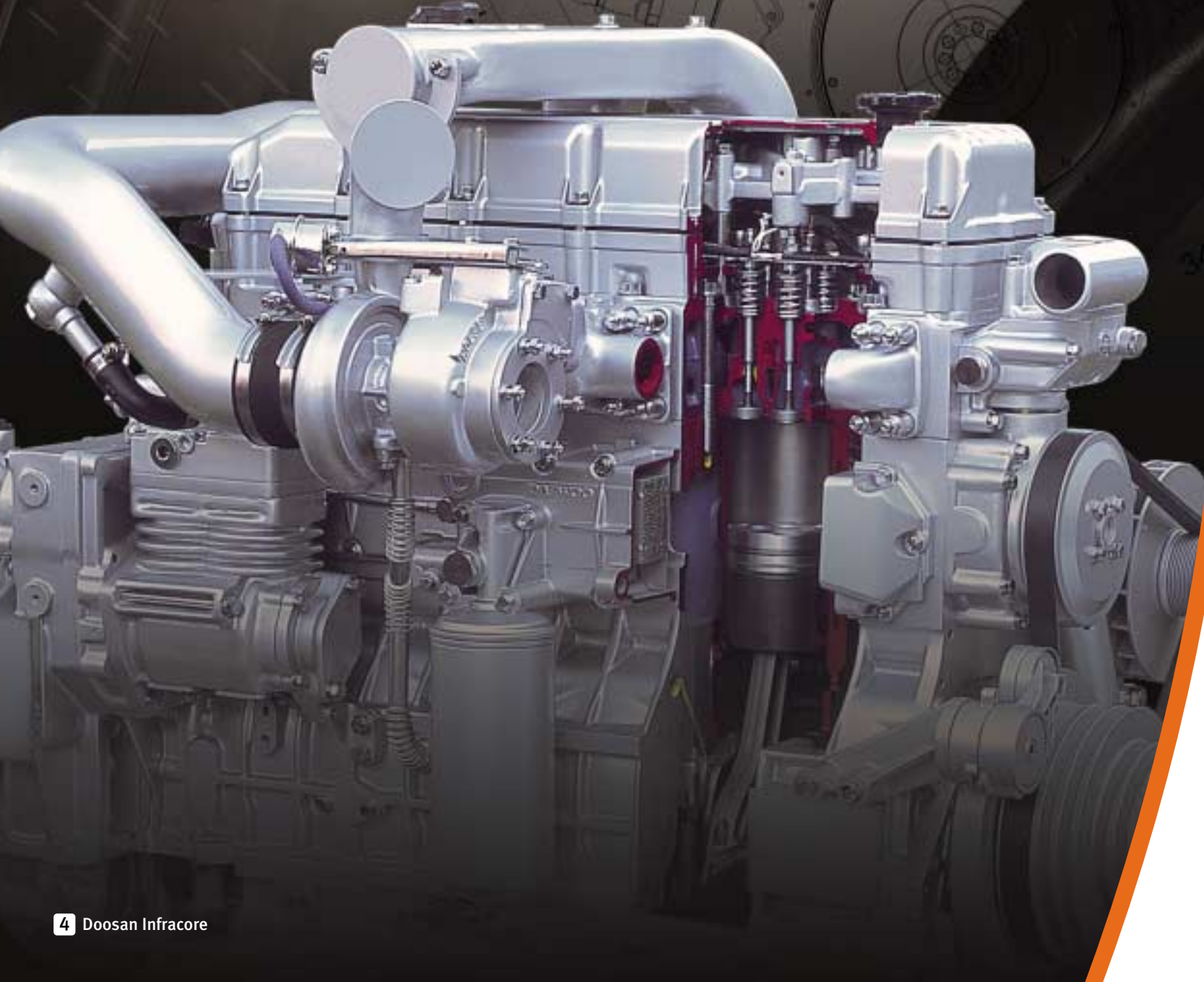

Doosan Infracore

Clean and Compact Power Pack for Your solutions

Whatever you need is in our automotive and Industrial applications. The brand Doosan DL06, DL08, DV11 Series engines have what it takes to get the job done. Fully electronic controlled common rail system matches the stringent emissions of EURO III/TIER III and provides the higher power plus all the reinforced performance. Power ranges from 147kW to 309kW. Doosan engines are designed for only thing in mind-YOU.



DL06 - EURO III / TIER III

- In-line, 6 cylinder, Turbo-Intercooled Type
- Bore x Stroke : 100mm x 125mm (5.9 Liter)
- Max.Power : 199kW[270ps] at 2500rpm

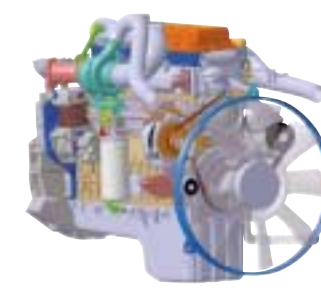

DL08 - EURO III / TIER III

- In-Line 6 Cylinder, Turbo-Intercooled type
- Bore xStroke : 108mm x139mm(7.6 Liter)
- Max. Power : 235kW[320PS] at 2200rpm



DV11 - EURO III / TIER III

- Vee 6 Cylinder, Turbo-Intercooled type
- Bore xStroke : 128mm x142mm(11.0 Liter)
- Max. Power : 309kW[420PS] at 1800rpm

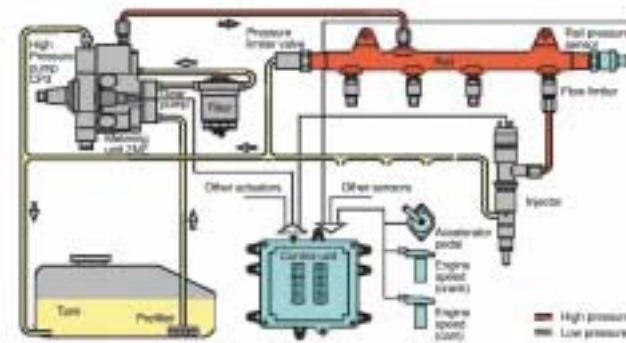

Electronic Common Rail Injection System

- High pressure injection(1600 bar)
- Delivers high torque at low engine speed
- Application flexibility relative to injection pressure and timing
- Multiple injection for quiet and optimized combustion
- Potential solution to the future emission challenge

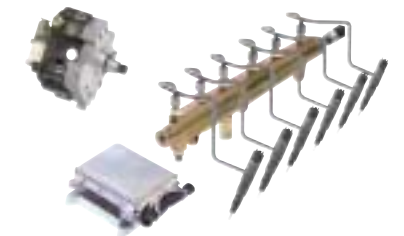

Common Rail Fuel System



4 Valve System



Turbocharger

Wastegate turbocharger allows optimized combustion at low speed as well as high speed.



New Combustion System

4-Valve per cylinder design increases air flow and allows central and vertical injectors mounting for improved combustion and low emission.

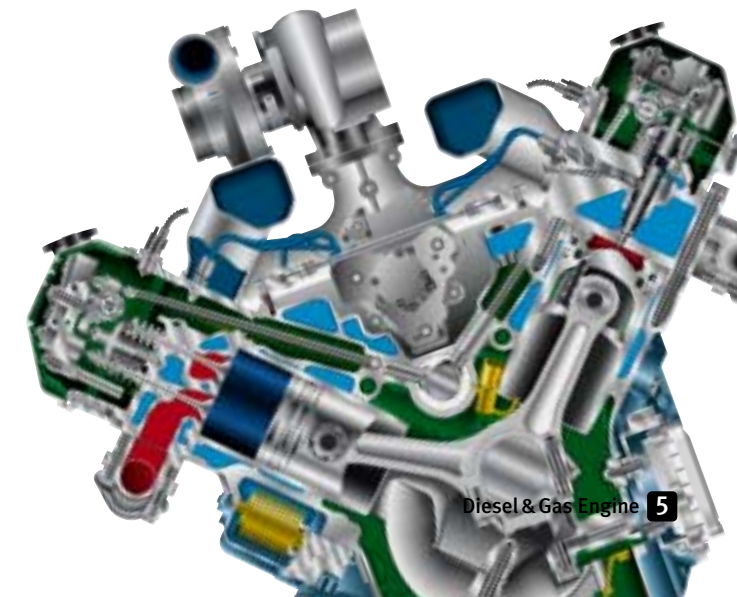



Doosan Infracore

Automotive Diesel Engines

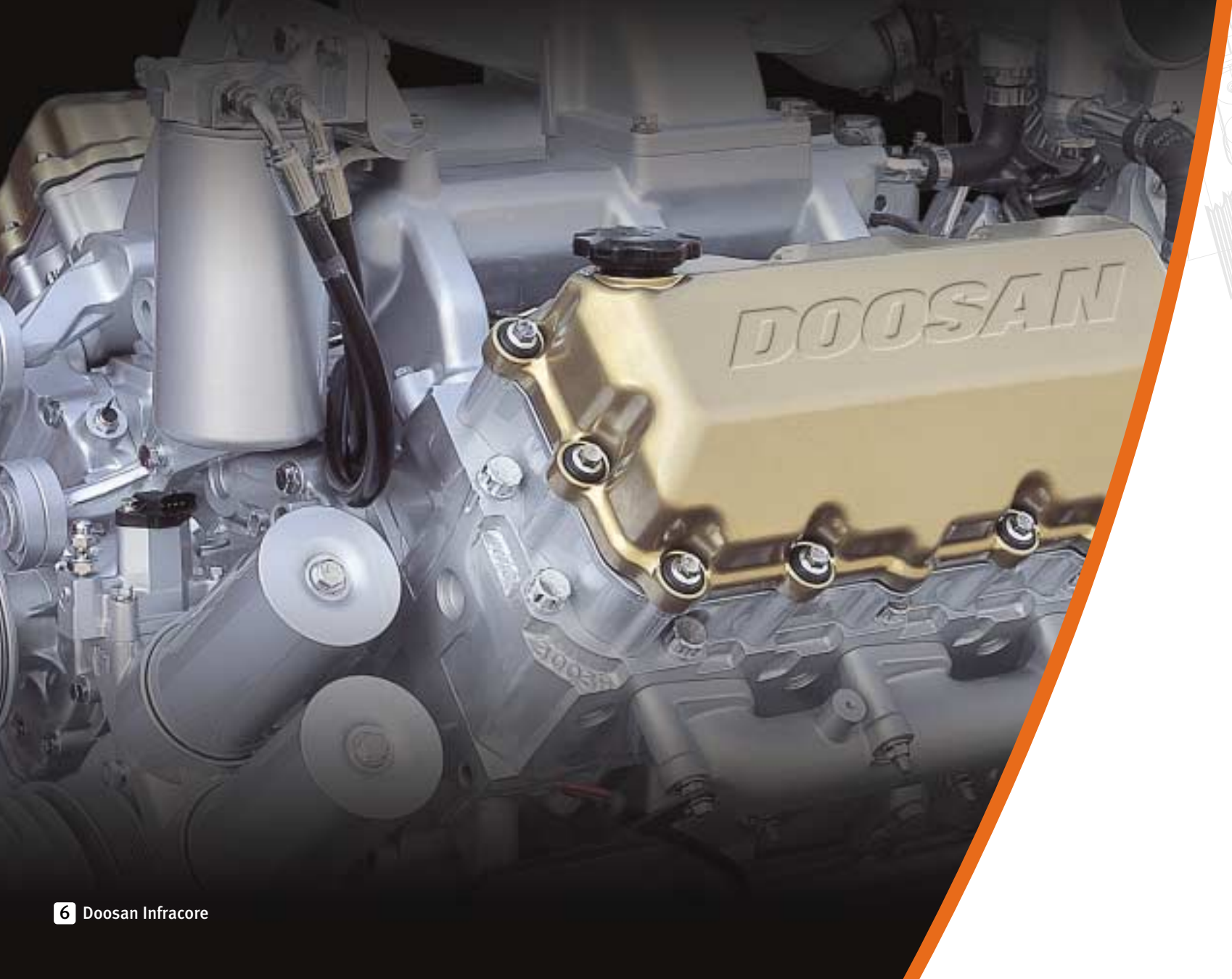

Automotive engines We independently developed low-emission diesel engines for heavy and medium duty vehicles in compliance with EURO-1 in 1995, EURO-2 in 1998 and EURO-3 in 2004. We have also been developing diesel engines responding to EURO-4, aiming at mass production late in 2007.

Doosan's research and development program has led to the introduction of three new diesel models in compliance with EURO-3. Those are DL06, 5.9litre In-line 6 cylinder rated 199kW at 2500rpm, DL08, 7.6litre In-line 6 cylinder rated 235kW at 2200rpm, and DV11, 11.0litre V 6 cylinder rated 309kW at 1800rpm.

Doosan now offers various kinds of engines from 134kW through 309kW with 14 models.

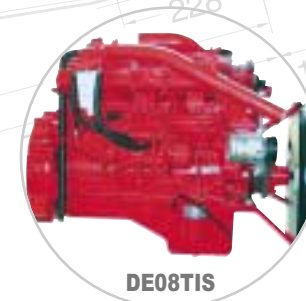
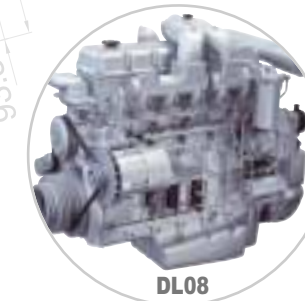
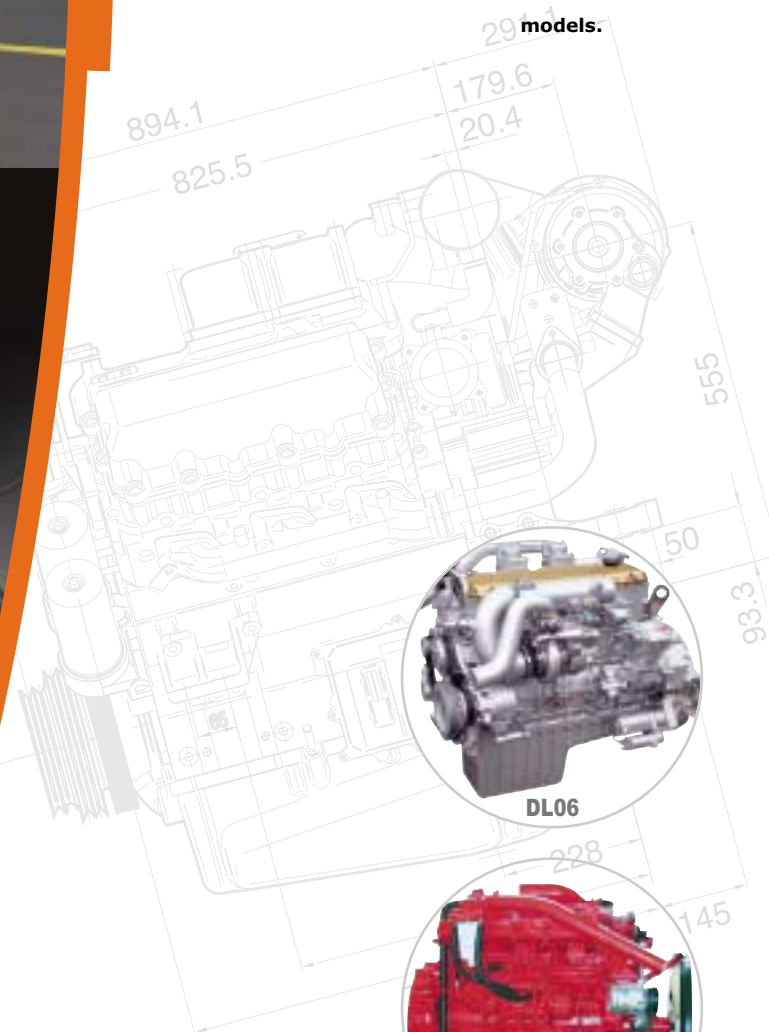

Automotive Engines

Model	Type		Displacement (Liter)	Bore x Stroke (mm)	Output (ISO 3046 Gross)		Dimension (L x W x H) (mm)	Dry Weight (kg)	Emission
	No. of Cyl.	Aspiration			Max. Power kW(ps)/rpm	Max. Torque Nm(kg.m)/rpm			
D1146	L 6	NA	8.1	111 x 139	134(182) / 2,500	564(57.5) / 1,600	1,169 x 914 x 788	730	EURO-I
D1146T	L 6	TC	8.1	111 x 139	151(205) / 2,300	736(75) / 1,200	1,154 x 812 x 920	745	EURO-I
D1146TI	L 6	TI	8.1	111 x 139	158(215) / 2,300	804(82) / 1,200	1,352 x 991 x 1,120	775	EURO-I
DE12	L 6	NA	11.1	123 x 155	173(235) / 2,200	800(81.5) / 1,400	1,358 x 777 x 1,109	920	EURO-I
DE12T	L 6	TC	11.1	123 x 155	221(300) / 2,200	1,079(110) / 1,300	1,312 x 825 x 1,015	880	EURO-I
DE12TI	L 6	TI	11.1	123 x 155	250(340) / 2,100	1,324(135) / 1,260	1,372 x 935 x 1,151	990	EURO-I
DV15T	V 8	TC	14.6	128 x 142	272(370) / 2,300	1,422(145) / 1,300	1,383 x 1,352 x 1,128	990	EURO-I
DV15TI	V 8	TI	14.6	128 x 142	309(420) / 2,100	1,668(170) / 1,200	1,383 x 1,352 x 1,053	950	EURO-I
DE08TIS	L 6	TI	8.1	111 x 139	165(228) - 176(240) / 2,300	804(82) - 883(90) / 1,200	1,352 x 1,001 x 1,120	790	EURO-II
DE12TIS	L 6	TI	11.1	123 x 155	213(290) - 265(360) / 2,100	1,128(115) - 1,422(145) / 1,260	1,372 x 932 x 1,151	990	EURO-II
DV15TIS	V 8	TI	14.6	128 x 142	287(390) - 309(420) / 2,100	1,570(160) - 1,666(170) / 1,200	1,383 x 1,352 x 1,053	1,020	EURO-II
DL06	L 6	TI	5.9	100 x 125	147(200) - 199(270) / 2,500	726(74) - 932(95) / 1,400	1,105 x 815 x 973	600	EURO-III
DL08	L 6	TI	7.6	108 x 139	184(250) - 235(320) / 2,200	883(90) - 1,324(135) / 1,200	1,356 x 919 x 1,153	815	EURO-III
DV11	V 6	TI	11.0	128 x 142	250(340) - 309(420) / 1,800	1,422(145) - 1,834(187) / 1,200	1,294 x 1,028 x 1,211	910	EURO-III



Doosan Infracore

Industrial engines We independently developed low-emission diesel engines for industrial equipment to meet the most stringent environmental demands which are exported to all over the world including advanced countries.

We have also been supplying diesel engines of TIER-2 and expanded its range of industrial engines with three new diesel engines in compliance with TIER-3 (DL06, 5.9litre In-line 6 cylinder rated 165kW at 2000rpm, DL08, 7.6litre In-line 6 cylinder rated 221kW at 2200rpm, and DV11, 11.0litre V 6 cylinder rated 294kW at 1800rpm). These engines are engineered to meet emission standards for U.S. and European applications in earthmoving and for forklift truck products.

These range of industrial engines supplied by Doosan can be adapted for use in variety of heavy machinery applications. Doosan now offers various kinds of engines from 53kW through 294kW with 18 models.

Industrial Diesel Engines

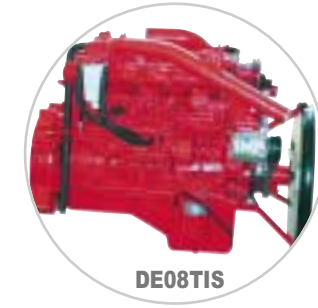

Industrial Engines

Model	Type		Displacement (Liter)	Bore x Stroke (mm)	Output (ISO 3046 Gross)		Dimension (L x W x H) (mm)	Dry Weight (kg)	Emission
	No. of Cyl.	Aspiration			Max. Power kW(ps)/rpm	Max. Torque Nm(kg.m)/rpm			
DB33	L 4	NA	3.3	102 x 100	53(72) / 3,000	196(20) / 1,800	819 x 629 x 691	283	
DB33A	L 4	NA	3.3	102 x 100	44(60) / 2,300	196(20) / 1,600	768 x 678 x 722	283	TIER-I/Stage-1
DB58	L 6	NA	5.8	102 x 118	96(130) / 2,800	373(38) / 1,600	1,157 x 632 x 806	450	TIER-I/Stage-1
DB58T	L 6	TC	5.8	102 x 118	104(142) / 2,500	451(46) / 1,600	1,172 x 668 x 931	480	TIER-I/Stage-1
DB58TI	L 6	TI	5.8	102 x 118	112(152) / 2,200	540(55) / 1,600	1,184 x 668 x 926	505	TIER-I/Stage-1
D1146	L 6	NA	8.1	111 x 139	115(156) / 2,200	520(53) / 1,500	1,207 x 837 x 1,043	700	TIER-I/Stage-1
D1146T	L 6	TC	8.1	111 x 139	140(190) / 2,200	697(71) / 1,400	1,233 x 786 x 1,159	720	TIER-I/Stage-1
D1146TI	L 6	TI	8.1	111 x 139	162(220) / 2,200	785(80) / 1,400	1,222 x 786 x 1,159	750	TIER-I/Stage-1
DE12T	L 6	TC	11.1	123 x 155	188(255) / 2,000	1,001(102) / 1,300	1,313 x 835 x 1,298	900	TIER-I/Stage-1
DE12TI	L 6	TI	11.1	123 x 155	213(290) / 2,000	1,148(117) / 1,300	1,313 x 835 x 1,295	920	TIER-I/Stage-1
DB58S	L 6	NA	5.8	102 x 118	74(100) / 2,200	373(38) / 1,600	1,177 x 632 x 878	450	TIER-II/Stage-2
DB58TIS	L 6	TI	5.8	102 x 118	127(172) / 2,200	667(68) / 1,500	1,210 x 790 x 890	500	TIER-II/Stage-2
DE08TS	L 6	TC	8.1	111 x 139	118(160) / 2,200	618(63) / 1,400	1,166 x 727 x 1,159	800	TIER-II/Stage-2
DE08TIS	L 6	TI	8.1	111 x 139	147(200) / 2,000	834(85) / 1,300	1,270 x 891 x 1,182	720	TIER-II/Stage-2
DE12TIS	L 6	TI	11.1	123 x 155	225(306) / 2,000	1,226(125) / 1,400	1,379 x 1,033 x 1,310	910	TIER-II/Stage-2
DL06	L 6	TI	5.9	100 x 125	165(225) / 2,000	844(86) / 1,400	1,213 x 815 x 1,166	570	TIER-III/Stage-3A
DL08	L 6	TI	7.6	108 x 139	221(300) / 2,200	1,246(127) / 1,200	1,304 x 907 x 1,193	770	TIER-III/Stage-3A
DV11	V 6	TI	11.0	128 x 142	294(400) / 1,800	1,825(186) / 1,200	1,097 x 1,028 x 1,319	930	TIER-III/Stage-3A



Gen-Set & Power Unit Diesel Engines

Doosan Infracore

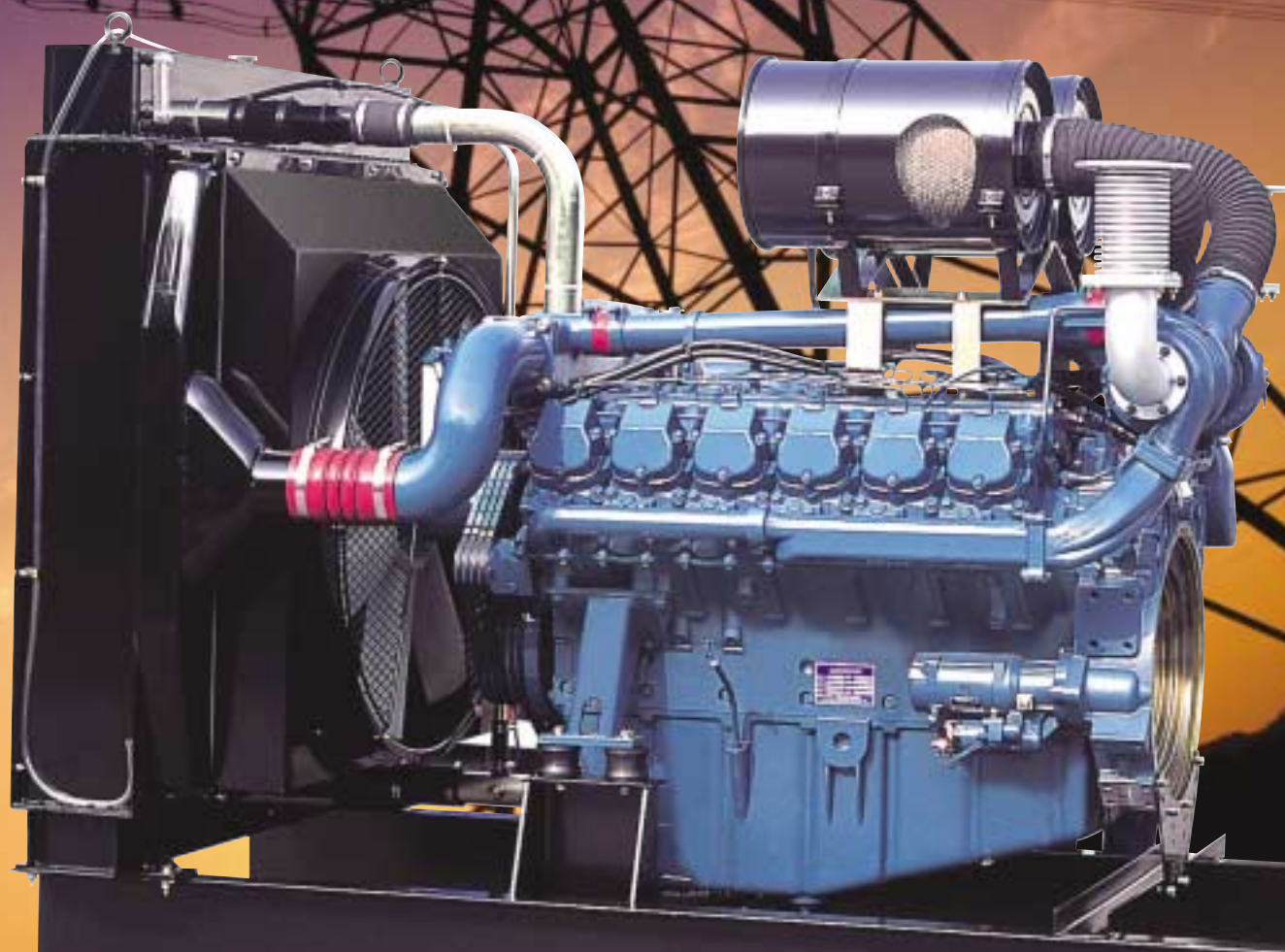

Generator engines Doosan offers 15 diesel models for standby and prime generator set applications.

The P086TI (8.1 litre in-line six-cylinder rated 223 kW at 1800 rpm), P126TI (11.1 litre in-line six-cylinder rated 298 kW at 1800rpm), and P222FE (21.9litre 4 valve V12 cylinde rated 711kw at 1800rpm) engines are available for gensets with the capability currently of moving beyond Tier 2 emission levels.

Power Unit engines Doosan also introduced 9 different models for power unit applications that range from 50 to 589 kW. These engine sizes are being offered with the variable-speed operation controls and configurations for power unit drive and power pack applications direct from the factory. The packages also include Doosan's standard or optional accessories.

Features

- Maintained performance
- Guaranteed power output 0 to +3%
- Low exhaust emissions
- Low noise levels
- G Drive, G Pac, P Drive & P Pac configuration

Low exhaust emission

The state of the art, high-tech injection, and charging system with low internal losses contributes to excellent combustion and low fuel consumption.

Durability & low noise

Designed for the easiest, fastest, and most economical installation. Well-balanced to produce smooth and vibration-free operation with low noise level. To maintain a controlled working temperature in cylinders and combustion chambers, the engine is equipped with piston cooling. The engine is also fitted with replaceable cylinder liners and valve seats/guides to ensure maximum durability and service life of the engine.

Easy service & maintenance

Easily accessible service and maintenance points contribute to the ease of service of the engine.



D1146T

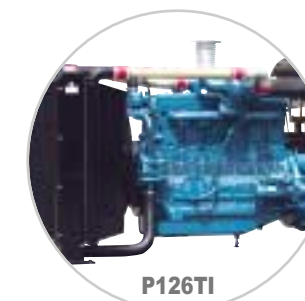

P126TI



P180LE



P222FE

Generator Engines (G Drive/G Pac)

Model	Type		Displacement (Liter)	Bore x Stroke (mm)	Output (ISO 3046 / 8528)		Dimension (L x W x H) (mm)	Dry Weight (kg)	Emission
	No. of Cyl.	Aspiration			kW(ps)@1800rpm Standby/Prime	kW(ps)@1500rpm Standby/Prime			
DB33	L 4	NA	3.3	102 x 100	35(47) / 32(43)	29(39) / 26(35)	870 x 705 x 749	310	TIER-I
P034TI	L 4	TI	3.3	102 x 100	60(82) / 55(75)	48(65) / 42(57)	870 x 728 x 841	335	TIER-I
DB58	L 6	NA	5.8	102 x 118	70(95) / 64(87)	59(80) / 54(73)	1,155 x 705 x 854	450	TIER-I
D1146	L 6	NA	8.1	111 x 139	105(143) / 96(130)	85(116) / 77(105)	1,224 x 727 x 973	720	TIER-I
D1146T	L 6	TC	8.1	111 x 139	138(187) / 125(170)	118(160) / 107(145)	1,277 x 824 x 1,074	780	TIER-I
P086TI-1	L 6	TI	8.1	111 x 139	191(260) / 174(237)	164(223) / 149(203)	1,242 x 918 x 1,099.5	790	TIER-I
P086TI	L 6	TI	8.1	111 x 139	223(303) / 205(279)	199(270) / 177(240)	1,242 x 918 x 1,100	790	TIER-II
P126TI	L 6	TI	11.1	123 x 155	298(405) / 278(378)	272(370) / 241(328)	1,383 x 870 x 1,207	910	TIER-II
P126TI-II	L 6	TI	11.1	126 x 155	342(465) / 307(418)	294(400) / 265(360)	1,383 x 913 x 1,207	910	TIER-II
P158LE-1	V 8	TI	14.6	128 x 142	402(546) / 366(498)	362(492) / 327(444)	1,484 x 1,389 x 1,162	950	TIER-I
P158LE	V 8	TI	14.6	128 x 142	458(623) / 402(547)	414(563) / 363(494)	1,484 x 1,389 x 1,162	950	TIER-I
P158LE-S	V 8	TI	14.6	128 x 142	481(654) / 441(600)	441(600) / 402(546)	1,484 x 1,389 x 1,162	961	TIER-I
P158FE	V 8	TI	14.6	128 x 142	492(669) / 441(600)	441(600) / 402(546)	1,492 x 1,389 x 1,240	997	TIER-II
P180LE-1	V 10	TI	18.3	128 x 142	498(677) / 454(617)	442(600) / 403(548)	1,557 x 1,389 x 1,248	1,175	TIER-I
P180LE	V 10	TI	18.3	128 x 142	540(734) / 497(676)	496(674) / 443(602)	1,557 x 1,389 x 1,248	1,175	TIER-I
P180LE-S	V 10	TI	18.3	128 x 142	567(771) / 519(705)	496(674) / 452(615)	1,557 x 1,389 x 1,248	1,188	TIER-I
P222LE	V 12	TI	21.9	128 x 142	649(883) / 591(803)	574(781) / 532(723)	1,717 x 1,389 x 1,288	1,575	TIER-I
P222LE-S	V 12	TI	21.9	128 x 142	682(927) / 625(850)	603(820) / 552(750)	1,717 x 1,389 x 1,288	1,591	TIER-I
P222FE	V 12	TI	21.9	128 x 142	711(967) / 659(896)	612(832) / 569(774)	1,719 x 1,389 x 1,305	1,650	TIER-II

Power Unit Engines (P Drive/P Pac)

Model	Type		Displacement (Liter)	Bore x Stroke (mm)	Output (DIN6270B)		Dimension (L x W x H) (mm)	Dry Weight (kg)	Emission
	No. of Cyl.	Aspiration			Max. Power kW(ps)/rpm	Max. Torque Nm(kg.m)/rpm			
PU034	L 4	NA	3.3	102 x 100	50(68) / 3,000	186(19) / 2,000	875 x 705 x 723	310	TIER-I
PU066	L 4	NA	5.8	102 x 118	85(116) / 2,800	353(36) / 1,600	1,155 x 705 x 775	450	TIER-I
PU086	L 6	NA	8.1	111 x 139	118(160) / 2,200	588(60) / 1,600	1,244 x 716 x 900	780	TIER-I
PU086T	L 6	TC	8.1	111 x 139	149(205) / 2,200	826(84) / 1,400	1,277 x 824 x 1,000	780	TIER-I
PU086TI	L 6	TI	8.1	111 x 139	213(290) / 2,200	1,095(112) / 1,600	1,242 x 918 x 1,100	792	TIER-II
PU126TI	L 6	TI	11.1	123 x 155	294(400) / 2,100	1,521(155) / 1,400	1,383 x 870 x 1,207	910	TIER-II
PU158TI	V 8	TI	14.6	128 x 142	397(540) / 2,100	2,117(216) / 1,500	1,484 x 1,389 x 1,162	950	TIER-I
PU180TI	V 10	TI	18.3	128 x 142	478(650) / 2,100	2,303(235) / 1,500	1,557 x 1,389 x 1,248	1,175	TIER-I
PU222TI	V 12	TI	21.9	128 x 142	589(800) / 2,100	3,205(327) / 1,500	1,717 x 1,389 x 1,288	1,575	TIER-I



Doosan Infracore

Marine Propulsion & Auxiliary Diesel Engines



Propulsion engines Doosan's complete product line of marine engines includes improvement and modifications to the fuel system as well as a new turbo design, improved exhaust manifold, and intercooler design. Doosan offers heavy, medium, and light-duty application engines available in output from 51kW to 883kW with 15 base engine configurations.

The products meet all known current and future IMO regulations on NOx emissions and offer increased fuel economy.

Doosan is able to supply complete propulsion and onboard electrical power packages. Doosan is also introducing a number of reduction gear boxes and stern arrangements for a complete package. Doosan's 13 models of marine auxiliary engines covering a range from 32 to 530 kW round out its family of marine products.



Marine Propulsion Engines

Model	Type		Displacement (Liter)	Bore x Stroke (mm)	Output (ISO 3046 kW(ps)/rpm)			Dimension (L x W x H) (mm)	Dry Weight (kg)	IMO, Emission
	No. of Cyl.	Aspiration			Heavy Duty	Medium Duty	Light Duty			
L034	L 4	NA	3.3	102 x 100	51(70)/3,000	-	-	822 x 703 x 822	372	TIER-I
L034TI	L 4	TI	3.3	102 x 100	88(120)/3,000	107(145)/3,300	-	844 x 703 x 774	402	TIER-I
L066TI	L 6	TI	5.8	102 x 118	132(180)/2,200	-	-	1,042 x 800 x 915	535	TIER-II
L136	L 6	NA	8.1	111 x 139	118(160)/2,200	-	-	1,188 x 764 x 926	743	TIER-I
L136T	L 6	TC	8.1	111 x 139	147(200)/2,200	-	177(240)/2,500	1,188 x 766 x 926	748	TIER-I
L136TI	L 6	TI	8.1	111 x 139	169(230)/2,200	-	-	1,188 x 825 x 926	773	TIER-I
L086TI	L 6	TI	8.1	111 x 139	210(285)/2,100	232(315)/2,300	265(360)/2,500	1,188 x 827 x 962	790	TIER-II
MD196T	L 6	TC	11.1	123 x 155	206(280)/2,000	-	-	1,235 x 855 x 1,073	975	TIER-I
MD196TI	L 6	TI	11.1	123 x 155	235(320)/2,000	-	-	1,235 x 855 x 1,073	1,009	TIER-I
L126TI	L 6	TI	11.1	123 x 155	265(360)/2,000	294(400)/2,100	-	1,235 x 855 x 1,073	1,060	TIER-II
V158TI	V 8	TI	14.6	128 x 142	353(480)/1,800	397(540)/2,100	500(680)/2,300	1,337 x 1,223 x 1,074	1,350	TIER-I
4V158TI	V 8	TI	14.6	128 x 142	390(530)/1,800	441(600)/2,100	603(820)/2,300	1,202 x 1,237 x 1,095	1,540	TIER-II
V180TI	V 10	TI	18.3	128 x 142	441(600)/1,800	478(650)/2,100	603(820)/2,300	1,495 x 1,223 x 1,169	1,550	TIER-I
V222TI	V 12	TI	21.9	128 x 142	530(720)/1,800	588(800)/2,100	736(1,000)/2,300	1,653 x 1,223 x 1,199	1,750	TIER-I
4V222TI	V 12	TI	21.9	128 x 142	588(800)/1,800	647(880)/2,100	883(1,200)/2,300	1,518 x 1,245 x 1,180	1,920	TIER-II

Marine Auxiliary Engines

Model	Type		Displacement (Liter)	Bore x Stroke (mm)	Output ISO 3046		Dimension (L x W x H) (mm)	Dry Weight (kg)	Emission
	No. of Cyl.	Aspiration			Kw(ps)@1800rpm	Kw(ps)@1500rpm			
AD034	L 4	NA	3.3	102 x 100	32(43)	26(35)	822 x 703 x 822	372	TIER-I
AD034TI	L 4	TI	3.3	102 x 100	55(75)	42(57)	844 x 703 x 774	402	TIER-I
AD066TI	L 6	TI	5.8	102 x 118	110(150)	96(130)	1,042 x 800 x 915	535	TIER-II
AD136	L 6	NA	8.1	111 x 139	93(126)	77(105)	1,188 x 764 x 926	735	TIER-I
AD136T	L 6	TC	8.1	111 x 139	125(170)	107(145)	1,188 x 766 x 926	748	TIER-I
AD136TI	L 6	TI	8.1	111 x 139	138(188)	115(157)	1,188 x 825 x 926	773	TIER-I
AD086TI	L 6	TI	8.1	111 x 139	186(253)	151(205)	1,188 x 827 x 962	790	TIER-II
AD196T	L 6	TC	11.1	123 x 155	181(246)	154(210)	1,235 x 855 x 1,073	975	TIER-I
AD196TI	L 6	TI	11.1	123 x 155	199(270)	173(235)	1,235 x 855 x 1,073	1,009	TIER-I
AD126TI	L 6	TI	11.1	123 x 155	247(336)	206(280)	1,193 x 854 x 1,072	1,060	TIER-II
AD158TI	V 8	TI	14.6	128 x 142	353(480)	302(410)	1,337 x 1,223 x 1,074	1,295	TIER-I
AD180TI	V 10	TI	18.3	128 x 142	441(600)	357(485)	1,495 x 1,223 x 1,169	1,545	TIER-I
AD222TI	V 12	TI	21.9	128 x 142	530(720)	446(606)	1,653 x 1,223 x 1,199	1,735	TIER-I

Marine Generator Sets

Model	Engine	Type		Displacement (Liter)	Bore x Stroke (mm)	Output ISO 3046		Dimension (L x W x H) (mm)	Dry Weight (kg)	Emission
		No. of Cyl.	Aspiration			kVA/Kw@1800rpm	kVA/Kw@1500rpm			
PNM30	AD034	4	NA	3.3	102 x 100	30/24	25/20	1,431 x 751 x 886	635	TIER-I
PNB60	AD034TI	4	TI	3.3	102 x 100	63/50	45/36	1,600 x 809 x 930	811	TIER-I
PNJ100	AD136	6	NA	8.1	111 x 139	100/80	85/68	1,960 x 789 x 1,132	1,328	TIER-I
PNK130	AD136T	6	TC	8.1	111 x 139	130/104	120/96	2,050 x 789 x 1,136	1,405	TIER-I
PND160	AD136TI	6	TI	8.1	111 x 139	159/127	133/106	2,095 x 789 x 1,136	1,489	TIER-I
PNE215	AD086TI	6	TI	8.1	111 x 139	215/172	170/136	2,095 x 789 x 1,136	1,613	TIER-II
PNJ280	AD126TI	6	TI	11.1	123 x 155	280/224	240/192	2,320 x 850 x 1,195	2,108	TIER-II
PNZ400	AD158TI	V8	TI	14.9	128 x 142	410/328	345/276	2,425 x 1,222 x 1,250	2,675	TIER-I
PNS500	AD180TI	V10	TI	18.3	128 x 142	500/400	415/332	2,580 x 1,222 x 1,250	3,138	TIER-I
PNY625	AD222TI	V12	TI	21.9	128 x 142	625/500	510/408	2,900 x 1,222 x 1,250	3,619	TIER-I

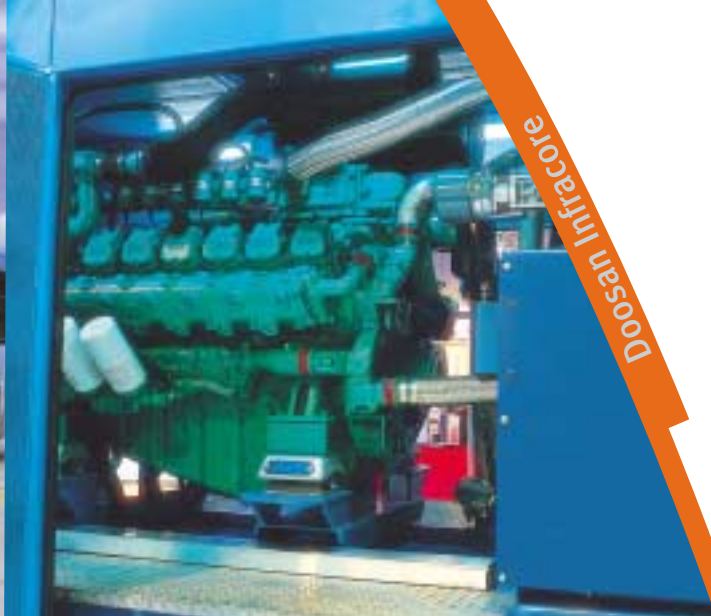

Natural Gas Engines



Natural Gas engines We have voluntarily taken the initiative regarding the protection of the earth environment and the enhancement of alternative energy utilization. In 1998, we developed ultra-low-pollution CNG (compressed natural gas) engines that are used for natural gas buses in Korea and other foreign countries. And recently, we have succeeded in developing LPNG (low pressure natural gas) engines for industrial equipment and generator applications.

In addition, Doosan has produced a line of heavy industrial gas engines for use in the standby, prime, and continuous power markets. Doosan offers 5 models ranging from 165 to 451 kW.

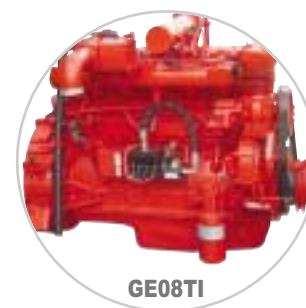

Core engine

- High grade cast iron cylinder block
- Liners in centrifugally cast iron, controlled plateau honing for quick ring bedding and excellent oil control
- Forged steel crankshaft
- Forged camshaft with induction hardening for in-line engine, carburised treatment for v-type engine
- High grade cast iron cylinder heads, each with two valves per cylinder
- Improved thermal durability, lower wear rate of valve seat ring by adapting metal powder alloy
- Wear resistance material valves with stellite armored face
- Excellent oil controlling valve stem seals
- Aluminum alloy pistons with three-ring pack, controlled profile and open dish type combustion chamber
- Split cap connecting rods, forged & shot peened steel with 2 bolt fixing
- Turbocharger with water cooled bearing housing and turbine housing

Gas/Ignition system

- Low pressure regulator and air/fuel mixer with mixture adjustment screw
- Altronic CPU-95 or CD1 ignition system and wiring harness
- Individual cylinder ignition coils

Lubrication system

- Gear driven lubricating oil pump, internally mounted
- Spin-on type replaceable lubricating oil filter
- Multi-plate type oil cooler, jacket water cooled
- Crankcase closed circuit ventilation (option)

Dedicated CNG engines

- Lean Burn system for Automotive application
- Low fuel consumption and low pollution.
- Low noise and Vibration

CNG Engines for Automotive

Model	Type		Displacement (Liter)	Bore x Stroke (mm)	Output (ISO 1585 Gross)		Dimension (L x W x H) (mm)	Dry Weight (kg)	Emission
	No. of Cyl.	Aspiration			Max. Power kW(ps)/rpm	Max. Torque Nm(kg.m)/rpm			
GE08TI	L 6	TI	8.1	111 x 139	169(230) / 2,200	804(82) / 1,400	1,316 x 1,037 x 1,112	775	EURO-IV
					176(240) / 2,300	883(90) / 1,300	1,169 x 1,003 x 812	745	
					191(260) / 2,300	981(100) / 1,300	1,202 x 1,003 x 812	745	
GE12TI	L 6	TI	11.1	123 x 155	213(290) / 2,200	1,128(115) / 1,320	1,372 x 834 x 1,064	890	EURO-III
					228(310) / 2,100	1,226(125) / 1,260	1,372 x 834 x 1,064	890	
					250(340) / 2,100	1,372(140) / 1,260	1,372 x 834 x 1,064	890	

Natural Gas Engines for Generator

Model	Type		Displacement (Liter)	Bore x Stroke (mm)	Output (ISO 3046 Gross)		Dimension (L x W x H) (mm)	Dry Weight (kg)	Emission
	No. of Cyl.	Aspiration			kW(ps)@1800rpm Standby/Prime	kW(ps)@1500rpm Standby/Prime			
GE08TI	L 6	TI	8.1	111 x 139	165(224) / 150(204)	141(192) / 128(174)	1,224 x 760 x 973	750	-
GE12TI	L 6	TI	11.1	123 x 155	225(306) / 200(272)	187(254) / 175(238)	1,405 x 854 x 1,072	910	-
GV158TI	V 8	TI	14.6	128 x 142	300(408) / 270(367)	253(344) / 230(313)	1,389 x 1,222 x 1,070	1,300	-
GV180TI	V 10	TI	18.3	128 x 142	375(510) / 340(462)	319(434) / 290(394)	1,495 x 1,222 x 1,169	1,520	-
GV222TI	V 12	TI	21.9	128 x 142	451(613) / 410(557)	385(523) / 350(476)	1,717 x 1,222 x 1,195	1,750	-

DOOSAN Diesel & Gas Engine Sales & A/S Network



- ALGERIA
- ARGENTINA
- AUSTRALIA
- AUSTRIA
- BANGLADESH
- BRAZIL
- CANADA
- CHILE
- CHINA
- COSTARICA
- CROATIA
- DENMARK
- EGYPT
- FRANCE
- GHANA
- GERMANY
- GREECE
- HOLLAND
- HONGKONG
- HUNGARY

- INDIA
- INDONESIA
- IRAN
- ISRAEL
- ITALY
- KOREA
- KUWAIT
- LEBANON
- LIBYA
- MALAYSIA
- MALDIVES
- MEXICO
- MOROCCO
- NEW ZEALAND
- NORWAY
- PAKISTAN
- PERU
- PHILIPPINES
- PORTUGAL
- QATAR

- ROMANIA
- RUSSIA
- S.AFRICA
- SAUDI ARABIA
- SINGAPORE
- SPAIN
- SRI LANKA
- SYRIA
- TAIWAN
- TANZANIA
- THAILAND
- TUNISIA
- TURKEY
- UAE
- U.K
- U.S.A
- VANUATU
- VENEZUELA
- VIETNAM
- YEMEN

Doosan Infracore R&D Center

Engine Research & Development center

Engine R&D center is constantly pursuing total customer satisfaction. We have a fully equipped ultra modern engine testing facilities which include exhaust gas analysis, run-in cells, cold test cells, and anechoic cell..... In order to assure the engine's endurance and reliability, we have conducted a variety of tests which include cold starting test, noise test and emissions gas test, high-speed test exceeding 130% of capacity, overload, thermal shock test and endurance test. In vehicle condition, off-road, rough terrain and fleet tests are being done and it will be accumulated up to 2.5 million kilometer long drive test.

Application

Doosan engines have been installed in over 1200 different applications.

We are confident that Doosan will provide total customer satisfaction in any applications;

Engines for automotive, truck and bus applications, as well as marine application for yachts, naval guard ships and patrol boats,

Engines for generators, Industrial engines for

mobile construction equipment and large special application vehicles.

Cold Chamber



Emission Test Cell



Anechoic Chamber



Durability Test Cell



Doosan Infracore